

UNIPLAY

HMI

USER MANUAL

About this Manual

Purpose

This manual provides the information required for the Selection, Wiring, Connection, Setup, Trial Operation and Functions of the Uniplay 7-A and Uniplay 10-A HMI.

Please read and understand this manual to ensure correct usage of the product.





Terms

Terms that may be used in this manual are defined as follows.

Term	Meaning
HMI	Human Machine Interface
Motion Perfect	The PC Tool for commissioning and programming the Trio product suite.

Symbols

The symbols that may be found in this document are defined as follows.

Symbol	Description
 DANGER	Indicates a hazard with a high level of risk that, if not avoided, may result in death or serious injury.
 WARNING	Indicates a hazard with a medium or low level of risk which, if not avoided, could result in minor or moderate injury.
 CAUTION	Indicates a potentially hazardous situation that, if not avoided, could cause equipment damage, loss of data, performance degradation, or unexpected results.
 IMPORTANT	Indicates precautions or restrictions that must be observed. Also indicates alarm displays and other precautions that will not result in machine damage.
 NOTE	Provides additional information to emphasize or supplement important points of the main text.

Safety Warning



During the installation or use of a control system, users of Trio products must ensure there is no possibility of injury to any person, or damage to machinery. Control systems, especially during installation, can malfunction or behave unexpectedly. Users must ensure that in all cases of normal operation, controller malfunction, or unexpected behaviour, the safety of operators, programmers or any other person is totally ensured.

Contents

Chapter 1 UNIPLAY HMI.....	1-6
1.1 Product Features.....	1-6
1.2 Specification Table.....	1-6
1.3 Dimensions.....	1-8
1.4 System Configuration.....	1-9
Chapter 2 Installation	2-10
2.1 Environmental considerations.....	2-10
2.2 Cabinet Installation.....	2-10
Chapter 3 Wiring and Connections.....	3-12
3.1 Connectors	3-12
Chapter 4 Operation	4-14
4.1 Motion Perfect.....	4-14
4.2 Initial Setup.....	4-14
4.3 Running	4-16
4.4 Creating an HMI Design.....	4-17
4.5 Uniplay Simulator	4-25
Chapter 5 Revision History	5-27

Chapter 1 UNIPLAY HMI

1.1 Product Features

Trio's unique UNIPLAY HMI system is a revolutionary way to make operator interfaces better, easier and more secure.

Uniplay HMI is a whole new way of creating and storing HMI screens. HMI screens can be created and linked to programs directly inside Motion Perfect. The HMI screens are stored with and loaded with the machine project on the Motion Coordinator.

- Single Point HMI Programming Inside Motion Perfect v5 and above
- Centralised Program / HMI screen Storage in a Motion Perfect Project
- Easily Display any Controller Data Type and Graphics
- No Need to Separately Program HMI Panel
- 7" and 10" UNIPLAY Sealed Touch Panels Available
- Connect up to 2 HMI's to your Motion Coordinator
- Ethernet Connection Reduces Wiring
- Simulator built into Motion Perfect

The Uniplay device is a high-quality, high reliability and cost-effective touch screen with an industrial ABS plastic shell.

1.2 Specification Table

Uniplay Model	UNIPLAY 7-A	UNIPLAY 10-A
Part Number	P561	P562
Resolution	1024x600	1024x600
Processor	600MHz	600MHz
Display Size	7" TFT LCD	10.1" TFT LCD
Brightness	450 cd/m2	400 cd/m2
Colours	24-bit	24-bit
Ethernet Port	1 x 10/100 Base-T	1 x 10/100 Base-T
Memory	Flash Storage: 128MByte	Flash Storage: 128MByte
	RAM: 128Mbyte	RAM: 128Mbyte

Uniplay Model	UNIPLAY 7-A	UNIPLAY 10-A
Power Supply	24Vd.c.+20%	24Vd.c.+20%
Max Power Consumption	~300mA@24vd.c.	~400mA~24vd.c.
Module Size (H x W x D)	200 x 145 x 34mm	273 x 213 x 36mm
Weight	0.56kg	0.92kg
Panel Cut-out Dimensions	192 x 138mm	260 x 202mm
CE marked for EMC	Yes	Yes
RoHS	Compliant	Compliant
Operating Temperature	0 to 50°C	0 to 50°C
Storage Temperature	-20 to 60°C	-20 to 60°C
IP Rating	Front IP65* Back IP20	Front IP65* Back IP20

* When fitted correctly to an appropriate panel.

1.3 Dimensions

Uniplay 7-A

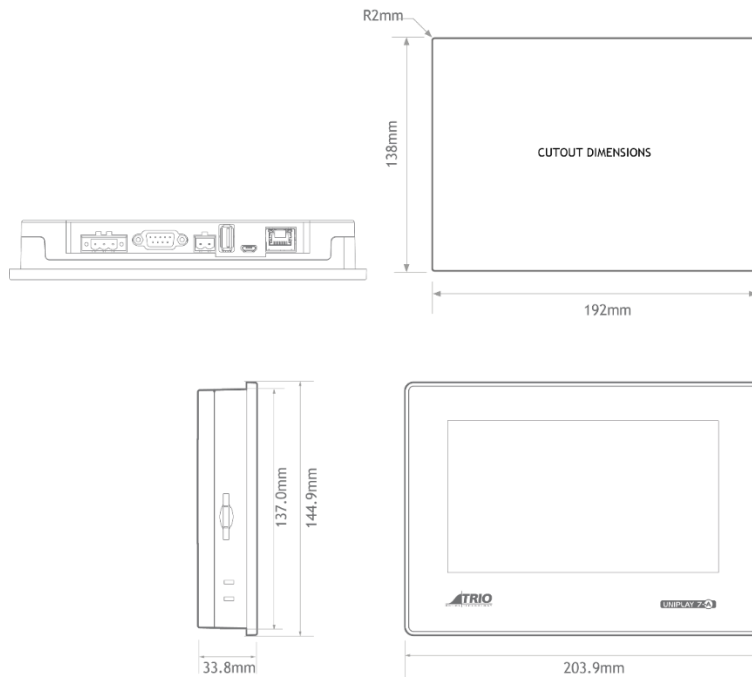

Uniplay 10-A

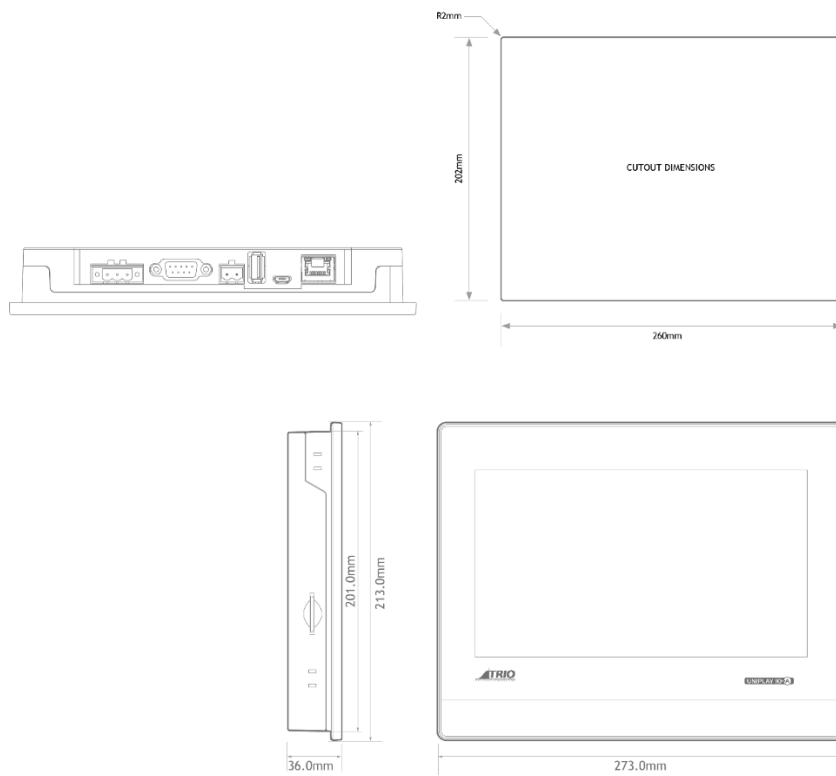

1.4 System Configuration

During application development and machine commissioning the typical configuration is to connect the Uniplay HMI to the Trio Motion Coordinator via an Ethernet switch. This allows for a Motion Perfect Ethernet connection to the Motion Coordinator for programming, debug and diagnostics.

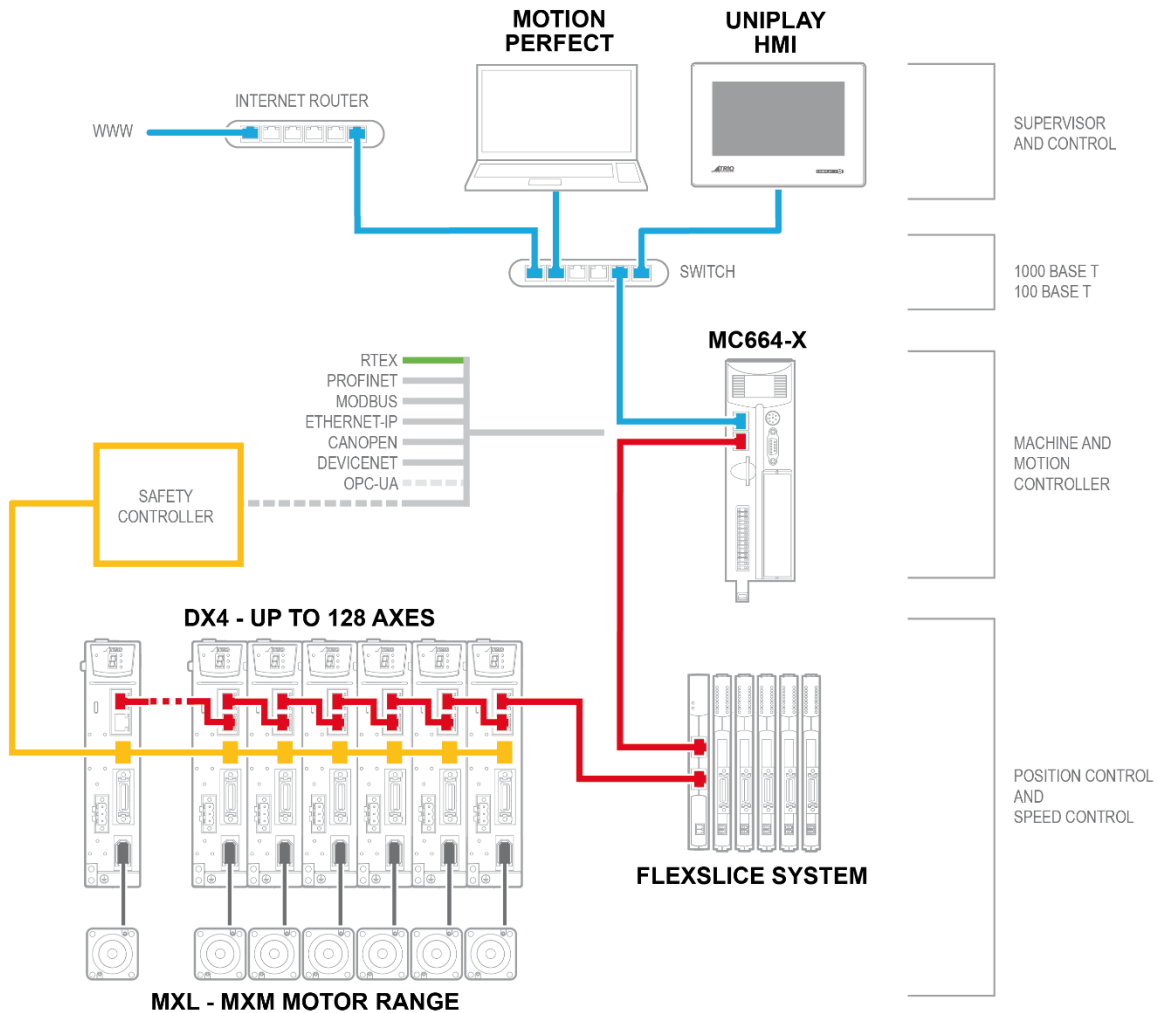

Once the application program is complete, the Uniplay HMI can be connected directly to the Ethernet port of the Trio Motion Coordinator.

Chapter 2 Installation

2.1 Environmental considerations



- Do not use in places that are exposed to direct sunlight, wind or rain.
- Do not use in places that are susceptible to chemical contamination, corrosive or flammable gases.
- Do not use in locations where there is a risk of explosion, such as where flammable gases, steam or dust are present.
- Do not cause condensation inside the device.
- Do not use in environments where the temperature changes significantly or where the humidity is high, this can cause condensation inside the device.

2.2 Cabinet Installation

The Uniplay HMI unit should be embedded into a panel or other suitable flat surface.

On the panel surface, cut a rectangular opening suitable for the unit to be mounted. Dimensions for the opening are:

Uniplay Model	UNIPLAY 7-A	UNIPLAY 10-A
Panel Cut-out Dimensions	192 x 138mm	260 x 202mm

Place the unit into the opening.

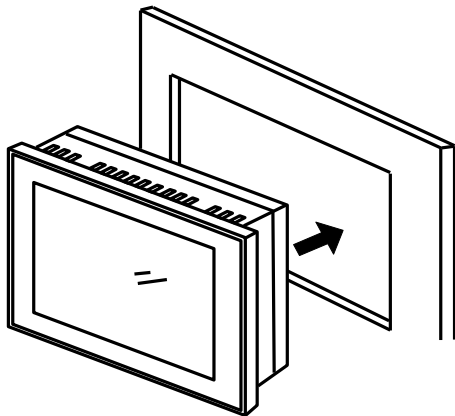

Insert the metal fixings supplied with the unit top and bottom. There are four mounting positions on the back of the Uniplay HMI unit, insert the fixing screws (included) and tighten them with a crosshead screwdriver.

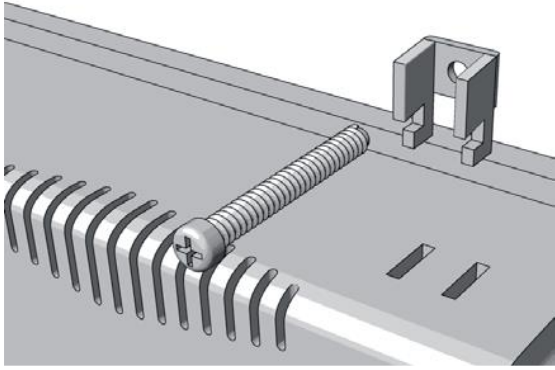

Ensure that the HMI seal is making good contact with the panel around the unit.

Chapter 3 Wiring and Connections

3.1 Connectors

The connectors are positioned on the bottom edge of the Uniplay HMI unit.

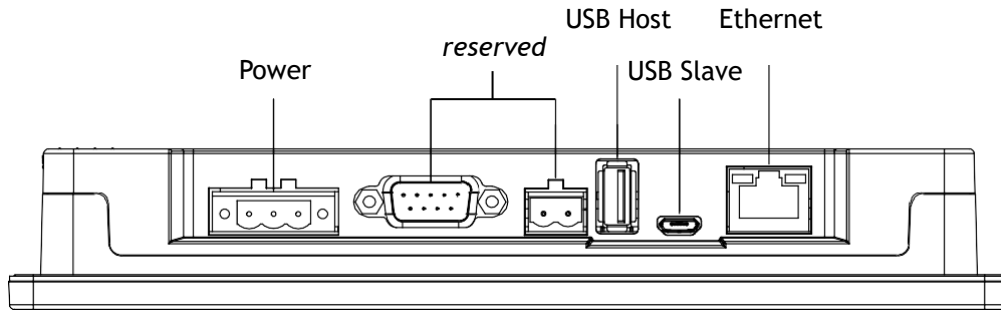

3.1.1 Power

Power terminal (Pin 1 to 3 from left to right)

Input voltage: DC24V ± 20%

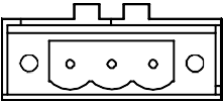
Connector	Pin	Function
	1	FG
	2	0V
	3	DC24V



Do not use a supply voltage other than that specified above. Using an incorrect power supply may damage the device

3.1.2 USB

Connector	Type	Function
	USB Type A	USB Host

	Micro USB	<i>reserved</i>
---	-----------	-----------------

3.1.3 Ethernet

The Ethernet interface is the main communication interface between the UNIPLAY HMI and the Trio Controller.

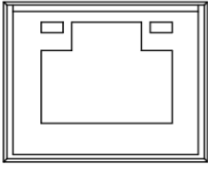
Connectors	Pin	Name	Function
 Pin 8 Pin 1	1	TX+	Send data +
	2	TX-	Send data -
	3	RX+	Receive data +
	4	—	—
	5	—	—
	6	RX-	Receive data -
	7	—	—
	8	—	—
	Shell	PE	Protecting earthing (shield)

Cable Description

Use category 5 (CAT5e SF/UTP) Ethernet communications cables for network connections. Metal shielded connectors are recommended to prevent signal interference.

Chapter 4 Operation

All configuration and programming of Uniplay is performed using Motion Perfect v5.0 (or above).

4.1 Motion Perfect

Motion Perfect is a Microsoft Windows™ based application for the PC, designed to be used in conjunction with Trio Motion Technology's range of multi-tasking motion controllers, servo drives, HMI and IO expansion products.

A PC with the following specifications is required to run Motion Perfect:

	Minimum	Recommended
Operating System	Windows 7 ¹	Windows 10
.NET Library	4.6.2	
Processor	Dual core	2 or more cores
RAM	2GBytes	4GBytes+
Hard Disk Space	200MBytes + space for projects	500MBytes
3D Graphics	DirectX 9	DirectX 11
Communications	Ethernet	Ethernet

[1] Windows 7 is no longer supported by Microsoft. Although basic functionality on Windows 7 will continue to be tested. Support will continue as long as possible, however, there is no guarantee that all functionalities will work or that support will continue.

Motion Perfect is a free download and is available to from the Trio web site (www.triomotion.com).

4.2 Initial Setup

To program a Uniplay device it must be connected to a Trio controller via Ethernet and the Trio controller needs to be connected to a PC via Ethernet and the PC needs to be running Motion Perfect.

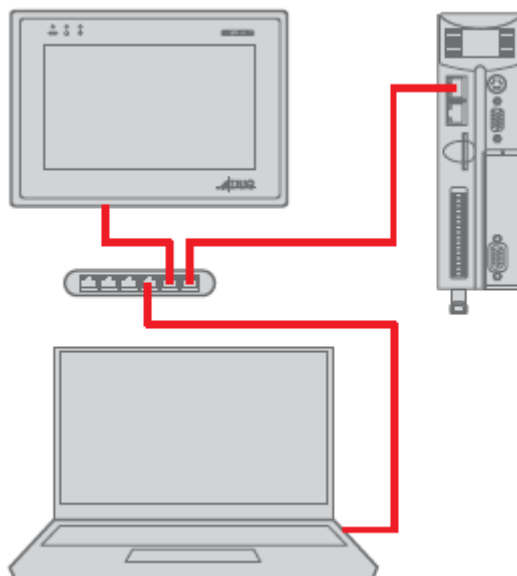

4.2.1 Initial Connection

To make the initial connection to a controller:

- Make sure that your controller is powered up and connected to the computer
- Start *Motion Perfect*. Once it has started up the initial screen should be displayed.
- Select "Connect in Sync mode" from the "Controller" menu. As *Motion Perfect* has not been connected before the "Connection" dialog will be displayed.
- Select the 'Ethernet' as the communications interface used by your controller. Then enter the IP address of the controller (default 192.168.0.250) and the TCP port (default 23).
- Click on the "Apply & Connect" button. The "Connect" will close and *Motion Perfect* will go into Sync Mode showing the the Controller Tree on the left.

The Uniplay panel default IP address is 192.168.0.251

The HMI panel must be aware of the Motion Coordinator IP address. If this is not at default use Motion Perfect Tools->Setup Uniplay HMI device screen to store the Motion Coordinator IP address into the panel.

Note: If there is no HMI design on the controller the HMI will display

'No HMI content found on the Motion Coordinator'

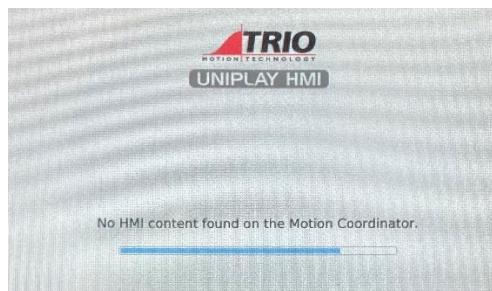

4.2.2 Updating Uniplay software

Motion Perfect will always contain the latest Uniplay software build. This software on the Uniplay panel can be updated using Motion Perfect Tools->Setup Uniplay HMI device. To update the Uniplay panel software click the Update... button, shown in the screen shot below.

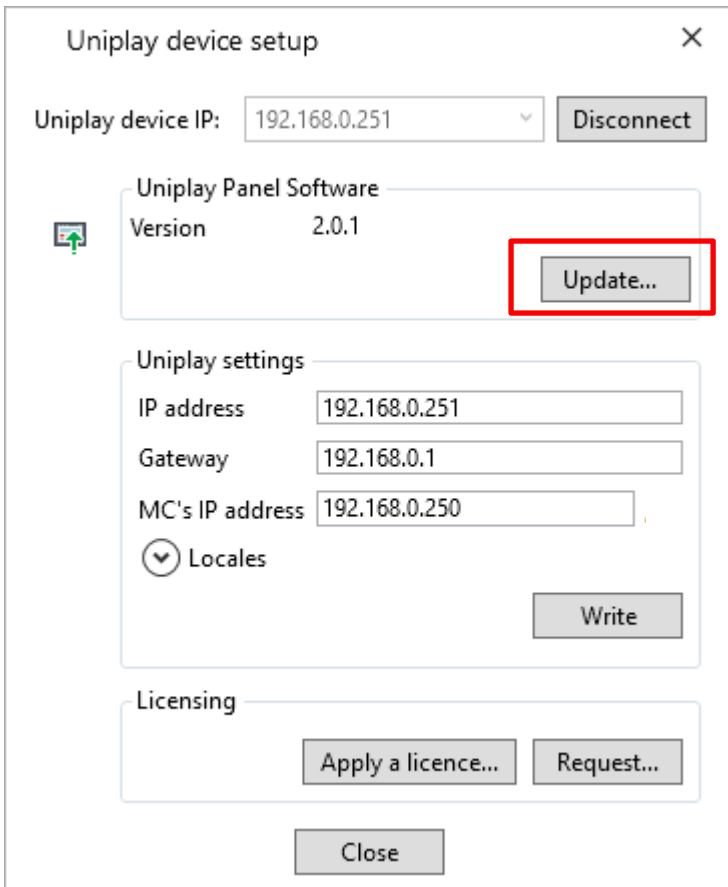

Motion Perfect will open a file explorer to allow selection of the software update. By default, this will open at the Motion Perfect folder with the latest software.

4.2.3 Licensing the Uniplay device

If the HMI shows a red border, this may mean that the software is not licenced correctly. Please contact Trio technical support, details can be found on the web site (www.triomotion.com).

4.3 Running

Once the system has been programmed, the Trio controller will serve the HMI pages to the Uniplay device, so there is no need for a connection to Motion Perfect.



4.4 Creating an HMI Design

Right mouse click on “Programs” or use Program->New on the menu

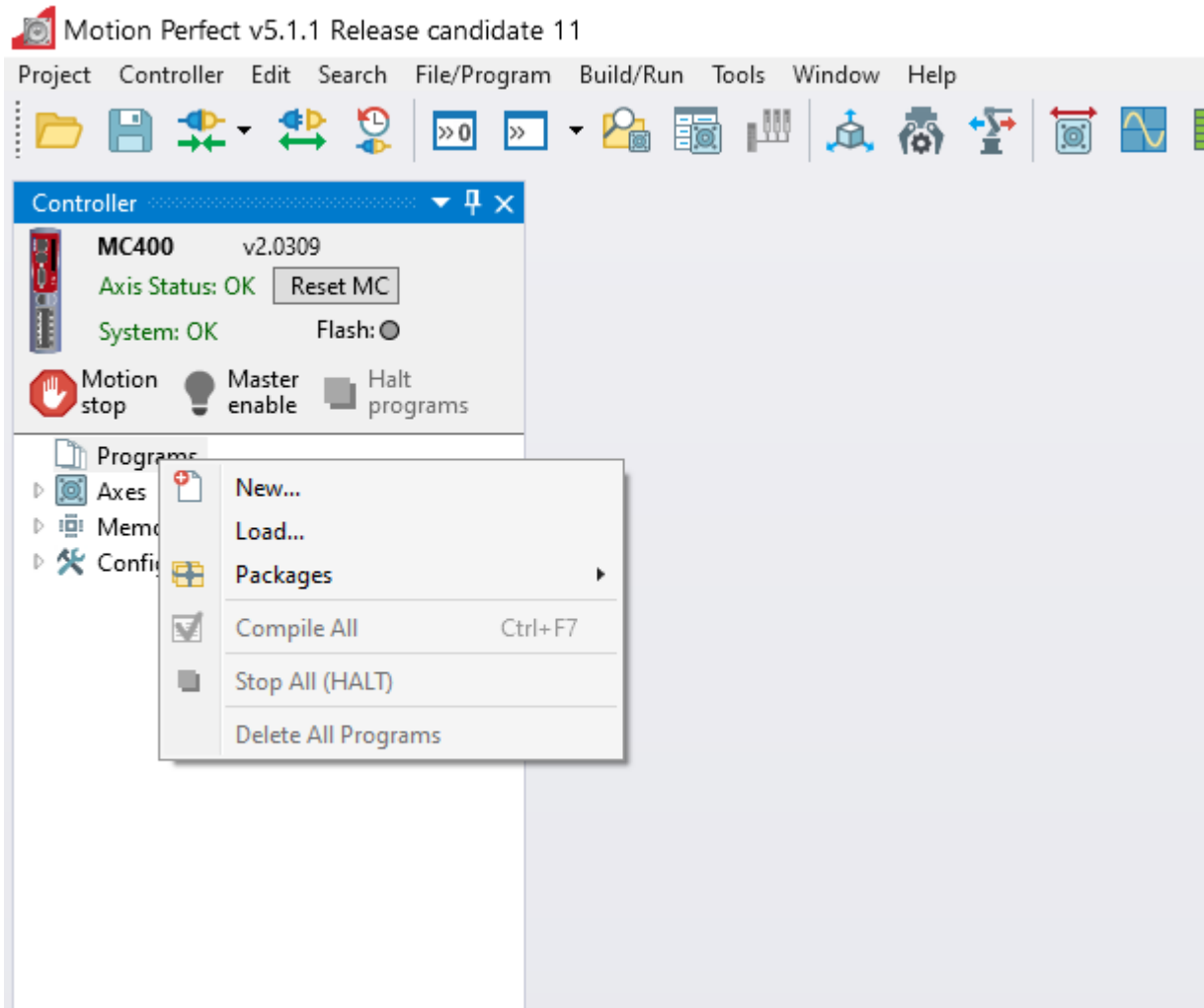

Ensure the HMI filter is checked and select ‘HMI Page’ under ‘HMI Design’ Select HMI Page under “Add New Program”, and give the page a name:

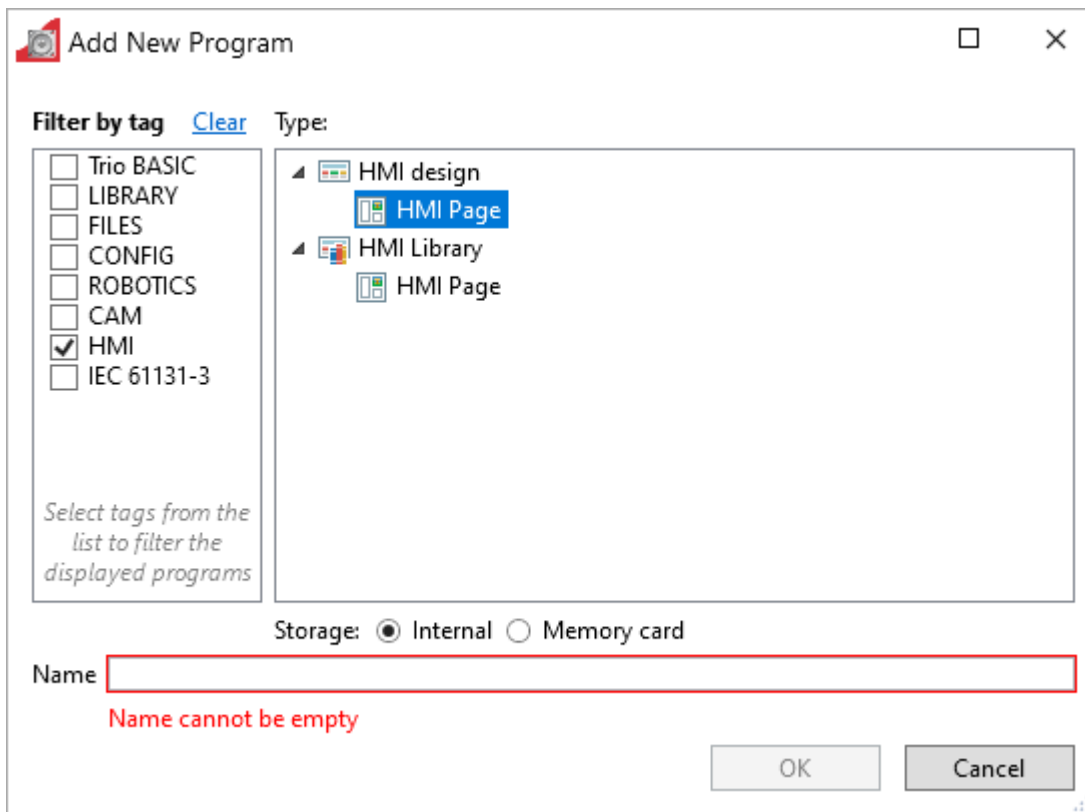

Select the target HMI type:

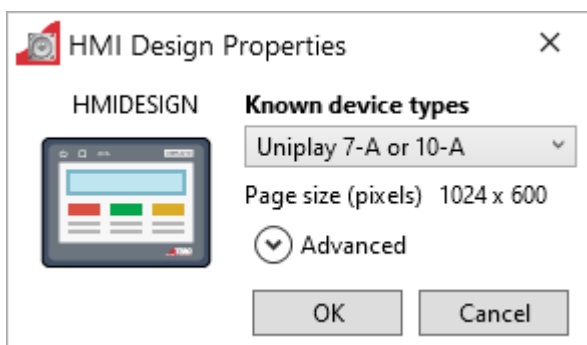

The new blank page will open in the editor:

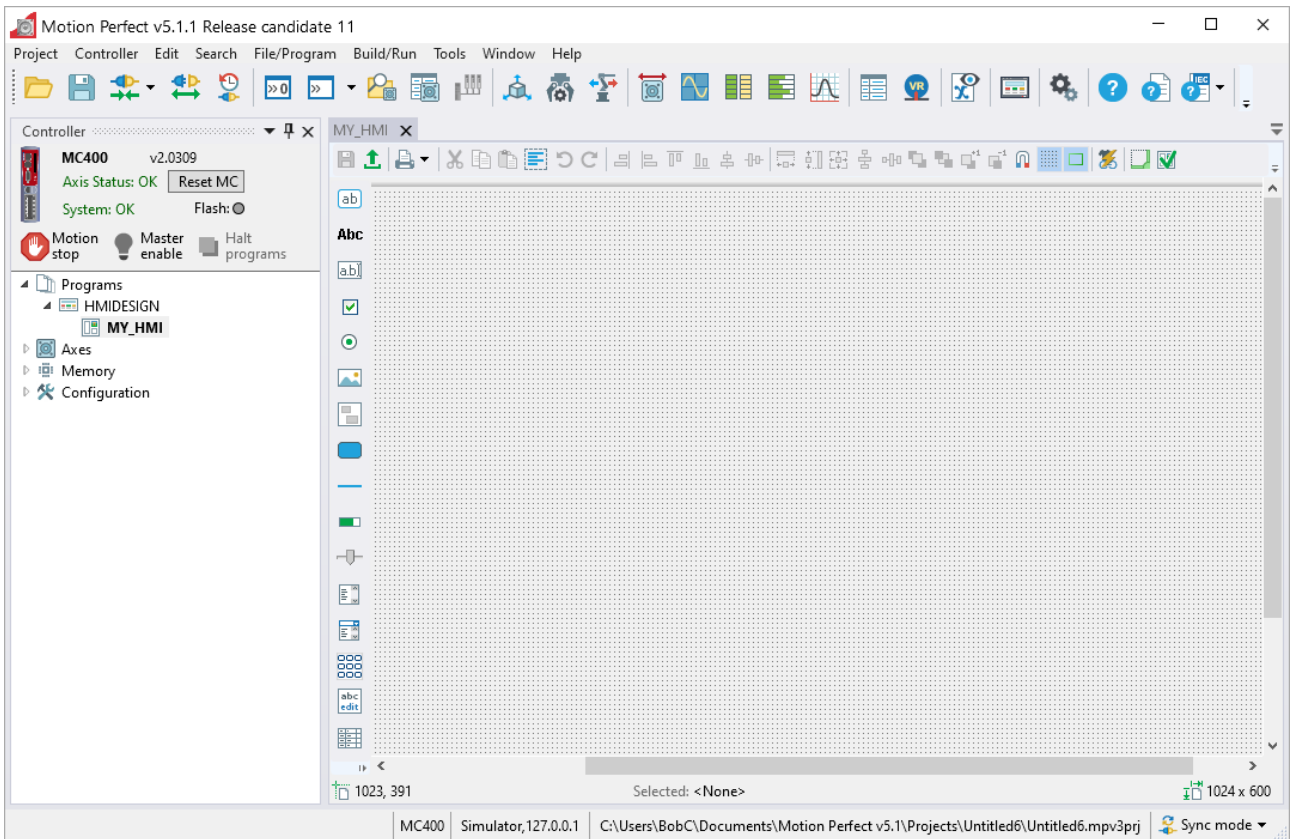

The components on the left-hand column can be dragged and dropped on the page.

The top border tools are used to edit and align pages.

In the simple example below a “Label” and a “TextBox” component have been dragged onto the HMI page:

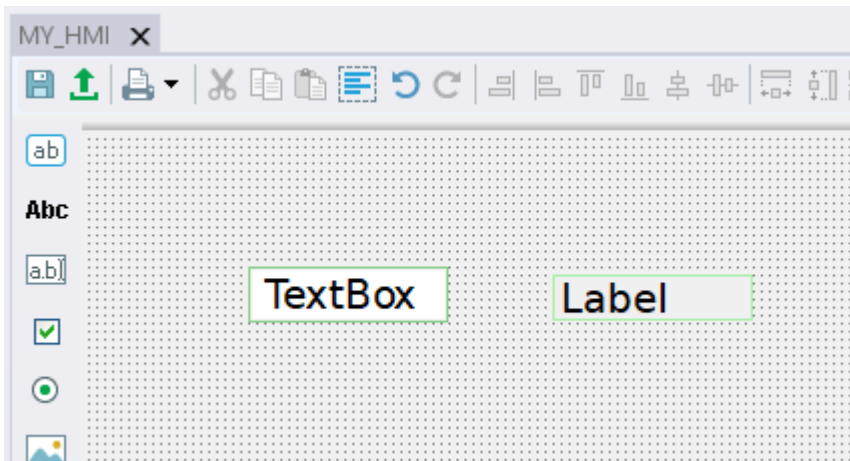

The properties of each component can be edited by a menu brought up using a right mouse click:

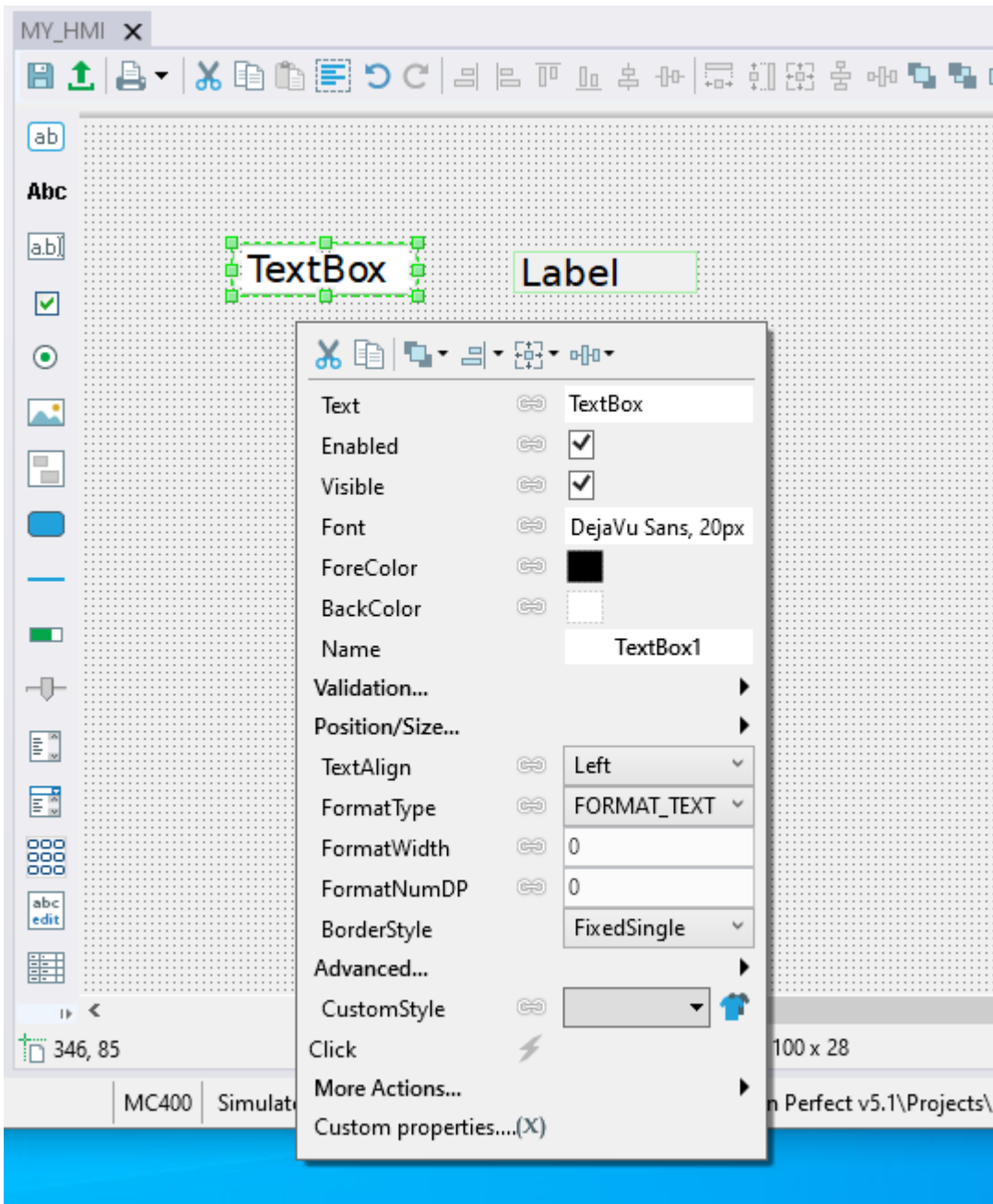

Further pages are made in the same way as the first page by right-clicking “Programs”.

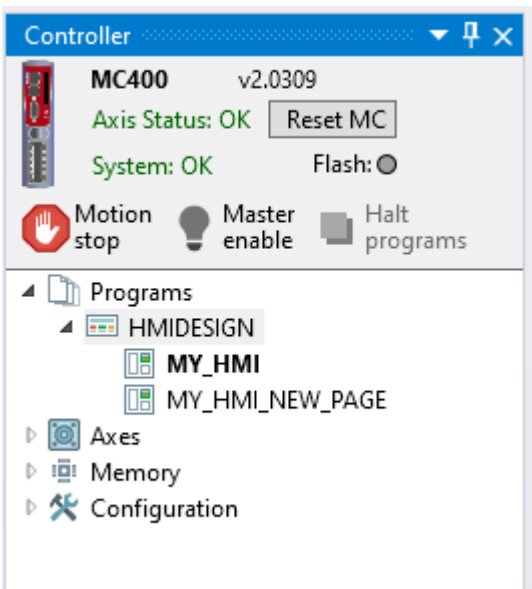

Note how one HMI screen is set to be the “Start-up page”. This is the first page that will be displayed and is highlighted in bold in the program tree.

The Start-up page can be changed to a different using the right-click menus on the page design.

4.4.1 Data Binding

The properties of each component can be fixed or linked to controller data. To link a component property to controller data click on the small “chain” bitmap alongside each property.

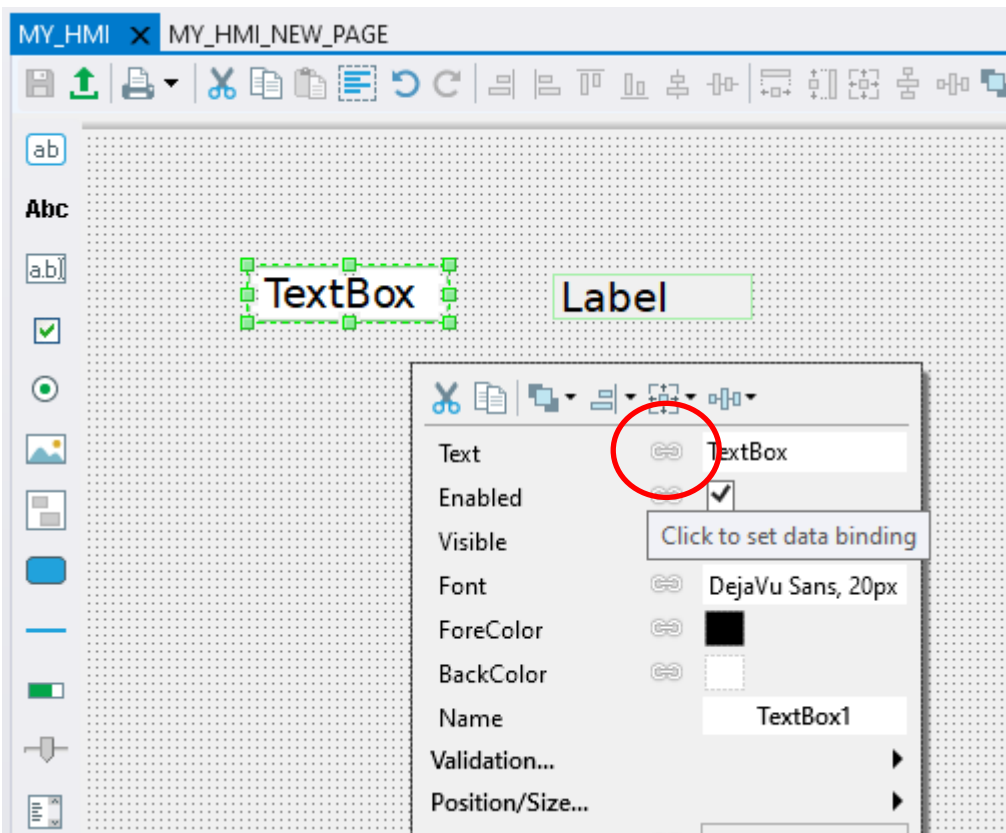

The menu then lets you choose what type of controller data to link to. This can be a program variable, for example in the program “MAINPROG” below, or VR, or other controller data types.

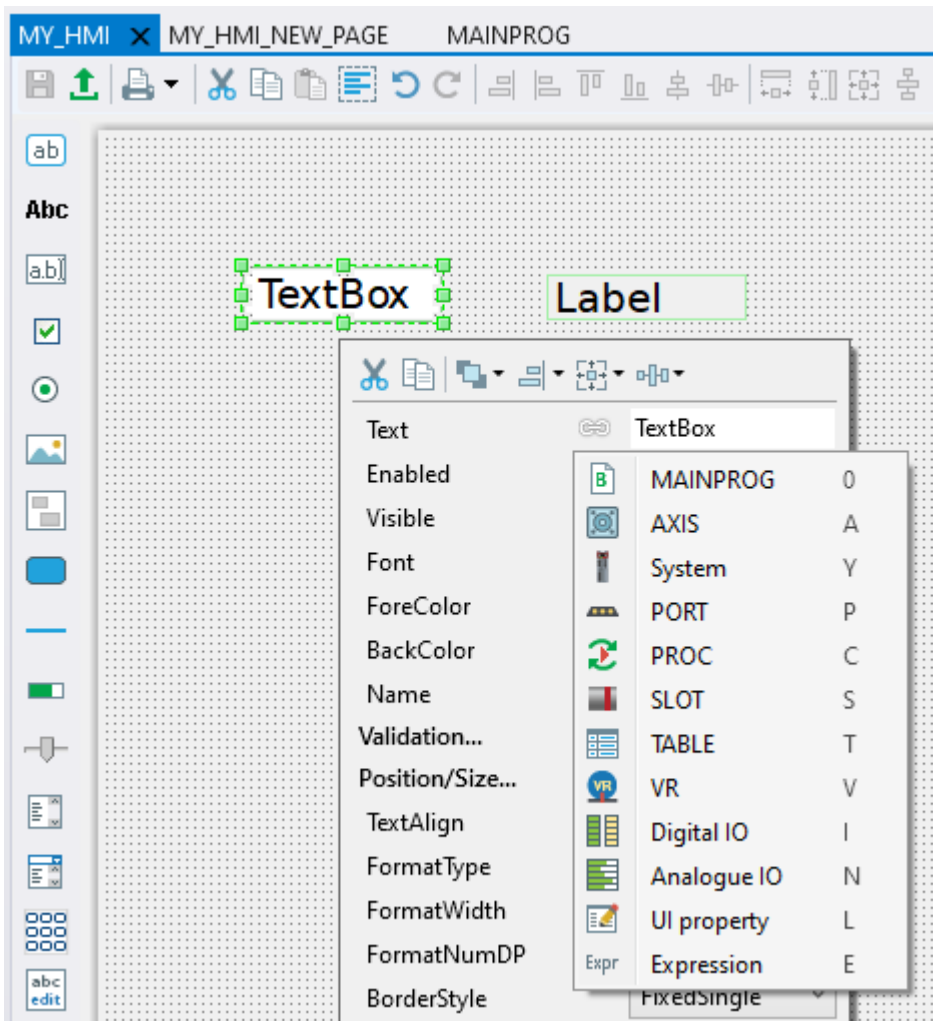

In this example we link the textbox “text” property to VR(50) in the controller.

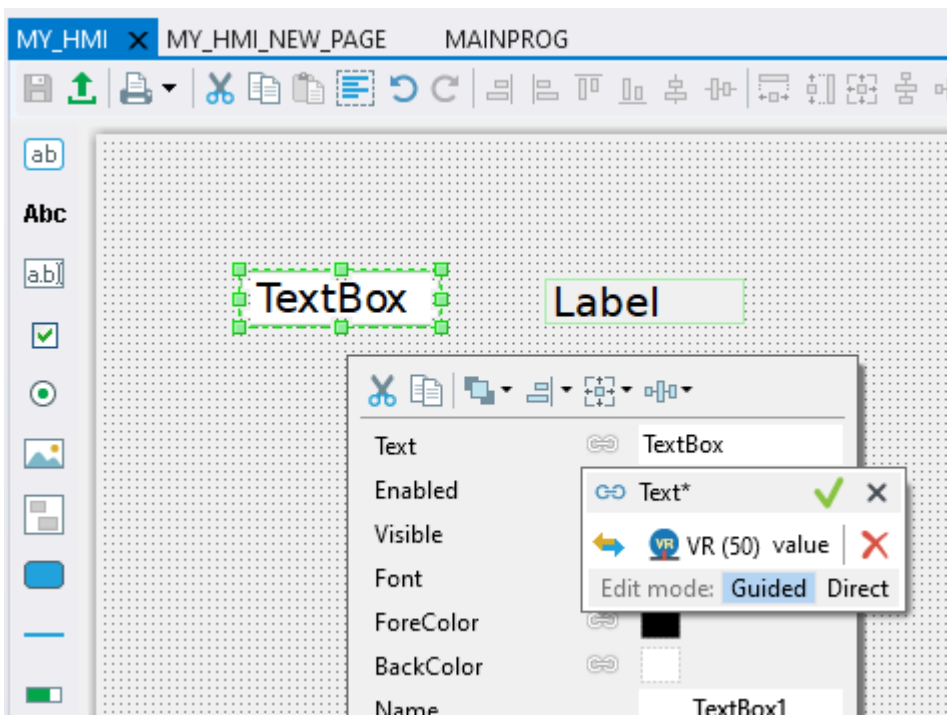

Click on the green tick to complete the link and the chain like “link” icon will turn blue.

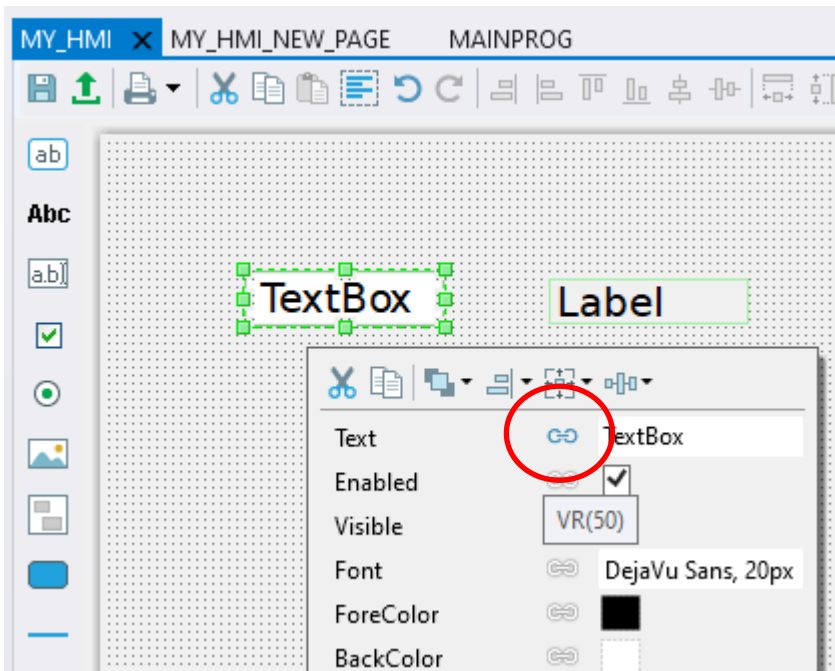

To see the screen run live on the Uniplay HMI simply click the green “upload” button:

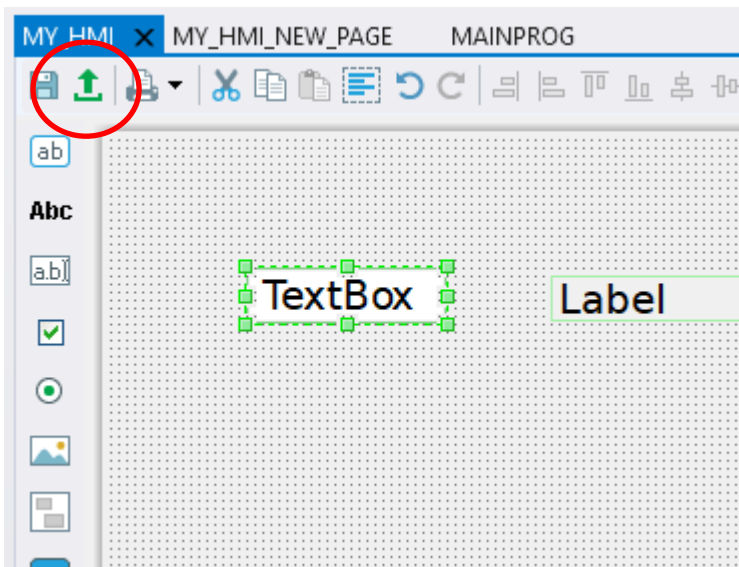

The HMI page(s) are automatically saved with the project and will be displayed on any connected Uniplay HMI, including the simulator (shown below).

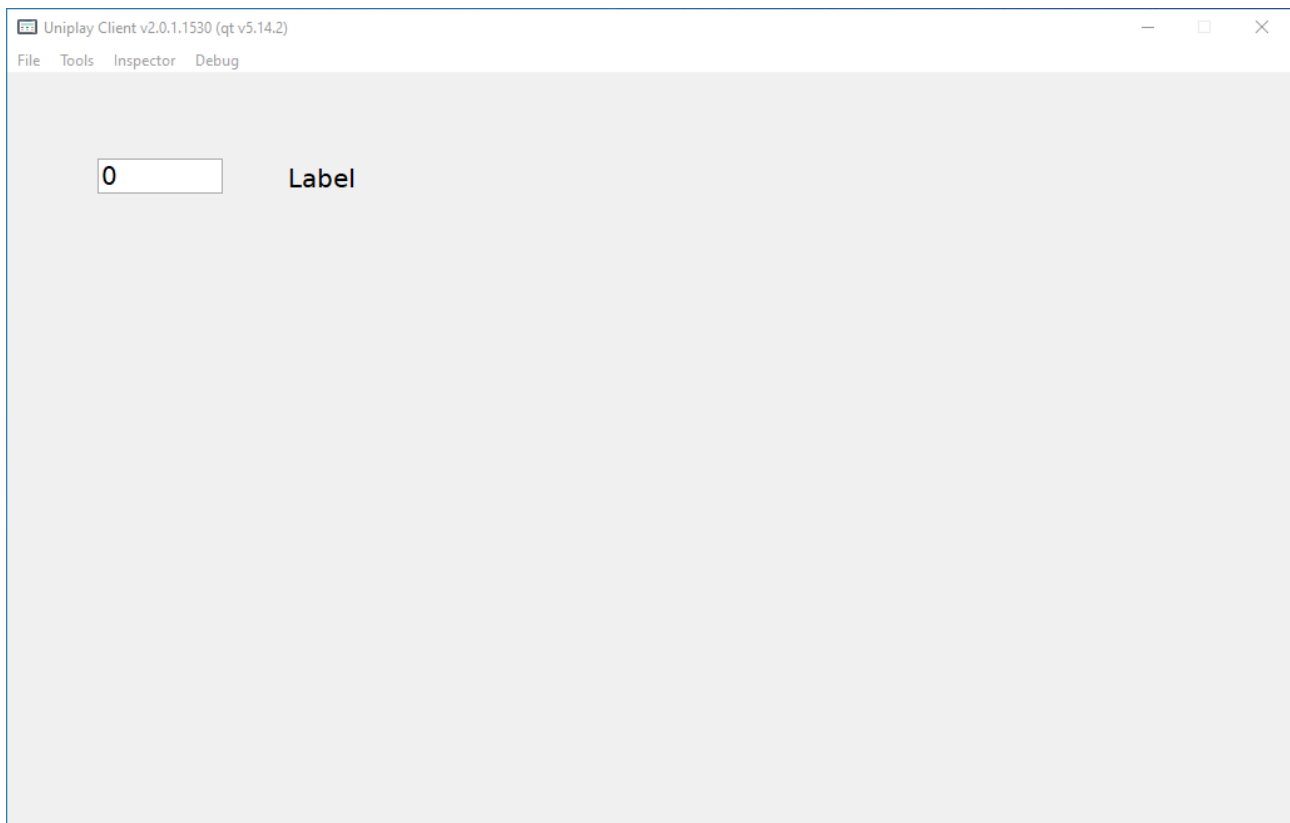

4.4.2 Event Binding

In addition to having properties and being linked to controller data, components can have “Actions” which will be performed, for example when a component such as a button is clicked.

To set an action select the “lightening” symbol alongside the action type.

The ‘Click’ action is shown on the right click menu. Other actions are available in ‘More Actions...’ as a sub menu.

A further menu level then allows you to set the action such as “Go to page”, “Set variable”, “Execute command” and others.

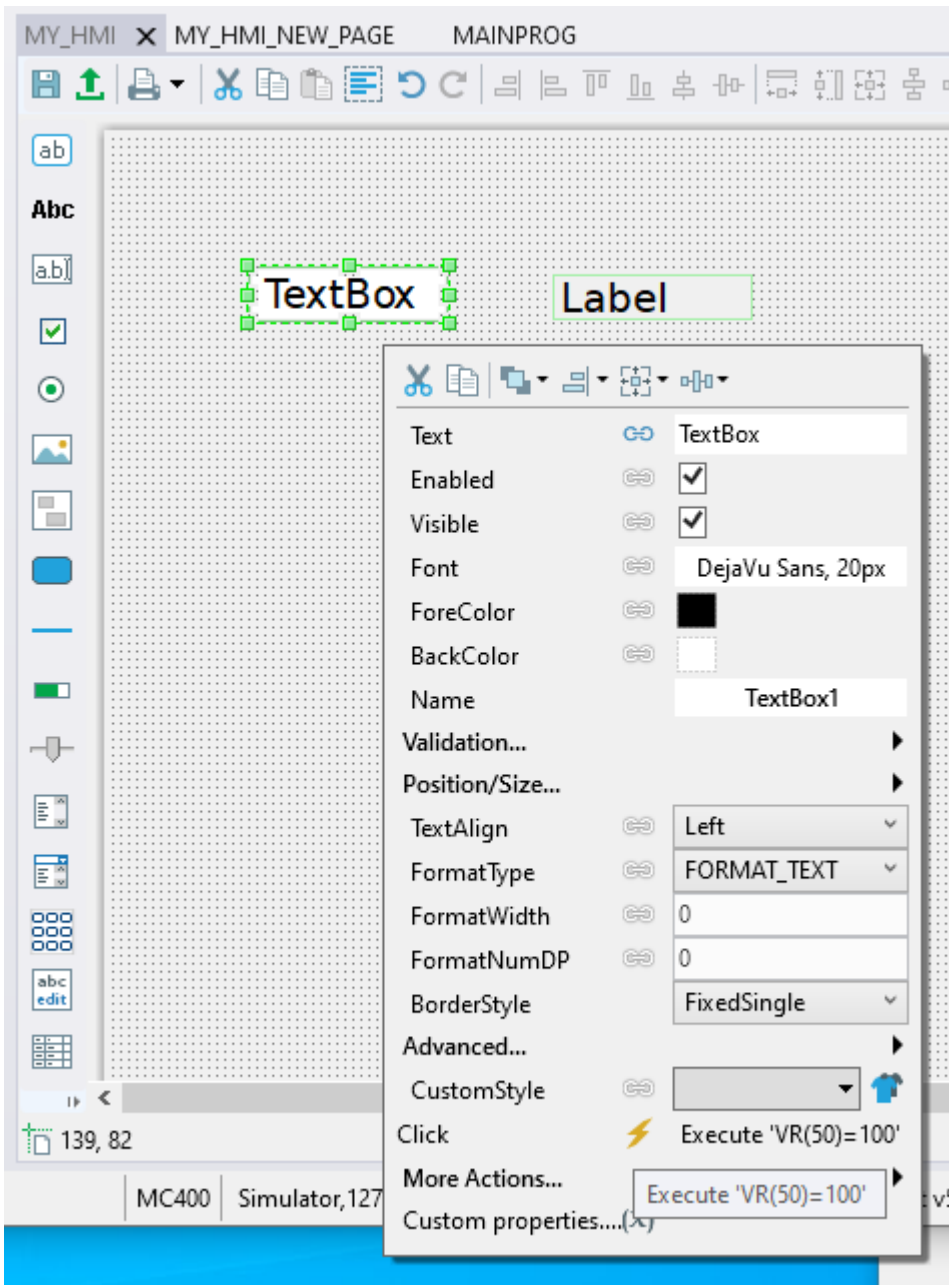

Note: If this option is used to execute a command in Trio BASIC, the line of code can include colon “:” separators to allow some multi-line sequences to be executed.

4.5 Uniplay Simulator

Motion Perfect provides a Uniplay simulator. This behaves in the same way as the real HMI but runs on the same PC as Motion Perfect allowing designs to be demonstrated and debugged without a physical Uniplay device.

The Uniplay simulator can be launched from the Motion Perfect toolbar, by click on the icon below:

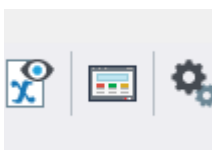

The simulator will need to be configured to know the IP address of the Motion Coordinator. This can be done from the Tools...Options menu.

Options

Profile: Custom

IP Address Ports Mode MC Events Locales Casing

Motion Coordinator: 127.0.0.1

HMI: 127.0.0.1

Gateway:

OK Cancel

Once the IP address has been configured correctly, the Motion Coordinator will serve the pages to the simulator in the same way as it would to a real Uniplay HMI.

It is also possible to run the simulator at the same time as the actual device, as long as the IP address of the simulator and the actual Uniplay device are different.

Chapter 5 Revision History

Date	Version	Revised Contents
April	1.0	Created

Trio Motion Technology Limited

 www.triomotion.uk